



GLASS HARDWARE G

Hauptkatalog

CRÉATIONS
D. GUIDOTTI

- Guidotti Produkte werden in Zusammenarbeit mit Designern, Architekten und Professionellen Glasverarbeitern entworfen und im Rahmen der existierenden Bestimmungen des europäischen Standarts (DIN 14428) für Sicherheit und Qualität in Frankreich hergestellt.

- *GUIDOTTI products are designed in close cooperation with architects, designers and glass professionals and are manufactured in France in the respect of existing European Standards (DIN 14428) of security and quality.*

Revel

Stuttgart

Paris

Firmensitz und Produktion
Head Office and Production

Tochterunternehmen und
Vertrieb Deutschland
Office & Stock in Germany

Ausstellung
Show-Room





● **CREATIONS D. GUIDOTTI**
Hersteller in Frankreich seit 1957
für Glastürbeschläge, Zubehör und
elektrische Schlösser.

● *CREATIONS D. GUIDOTTI*
Manufacturer in France since
1957 of fittings for glass doors
and electric locking devices.



Hotels wählen Creations D. Guidotti

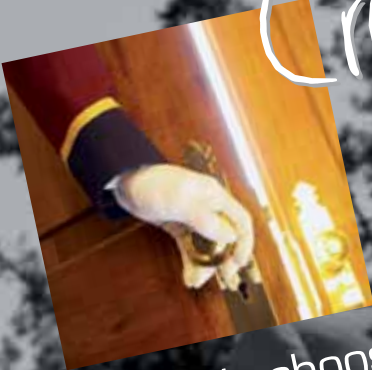

Hotels choose Créations D. Guidotti

● Für Ihre Bäder verwenden diese Hotels Beschläge der Firma Creations D. GUIDOTTI.

● For their bathrooms, the exceptional hotel choose Créations D. GUIDOTTI.

- *CARLTON Cannes*
- CROWNE PLAZA Dubai*
- FOUR SEASONS Costa Rica*
- GEORGES V Paris*
- INTERCONTINENTAL Berlin*
- MARRIOT Pune India*
- MARRIOTT Paris*
- MARRIOTT Warsaw*
- RADISSON Dubrovnik*
- RITZ-CARLTON Shanghai*
- ROYAL MANSOUR Casablanca*
- SHERATON Gdansk*
- SCHLOSSHOTEL KAPS Kitzbühel Austria*
- MÖVENPICK Flughafen Stuttgart*

TOSKANA

AQUASTAR

Nach der Montage der Scharniere die Inbusschraube um eine halbe Umdrehung öffnen.

Türe auf gewünschte Position stellen und die Inbusschraube fest anziehen.

Die im Katalog angegebenen Glasbearbeitungen beziehen sich auf die Grundstellung der Scharniere und müssen bei Gradänderung angepasst werden.

After mounting the hinge, unscrew, half turn, the Allen screw of the hinge placed at the top or bottom of the hinge.

Adjust the orientation of the door, then tighten the Allen screws.

The drawings showing the holes to drill are given in our catalogue for basic adjustment and have to be modified when changing the angle.



TOSKANA

AQUASTAR

Das Multi-Positions Scharnier

The multiposition hinge

- - Einseitig nach Innen oder Außen öffnende Türe
- Selbstschließung für die letzten 20 °
- Einfache Glasausschnitte - 2 Löcher
- Absolute Dichtigkeit, da Dichtprofil durchgezogen werden kann
- Ein Model für viele Installationsanwendungen

- - Inward OR outward opening of the door
- Self-closing function of the door in the last centimeters
- Simple glass preparation: only holes to drill, no notch
- Guarantee of a perfect sealing of the shower cabin: hinge is mounted on PVC seal (by pass system)
- Only one model of hinge for many installation possibilities : by adjusting the Allen screw, you can position the door in any angle



CS 716/CA 726



Wandmontage nach außen öffnend
Wall mount outward opening

Glas / Glass :
Stärke/Thickness : 6.8.10 mm
6 + 10 mm bitte angeben/tell us
Breite/Width : 800 mm max.
Gewicht/Weight : 35 kg max.

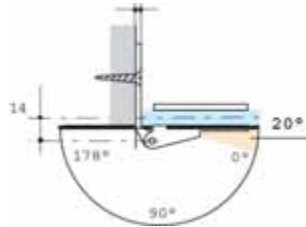

Glas/Wand 6 mm
Glass/Wall 6 mm

Scharnier/Hinge
massives Messing gefräst/Solid brass
Chromstärke/Chrome thickness : 40 µ

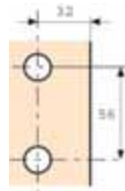

2 Bohrungen/Holes Ø18

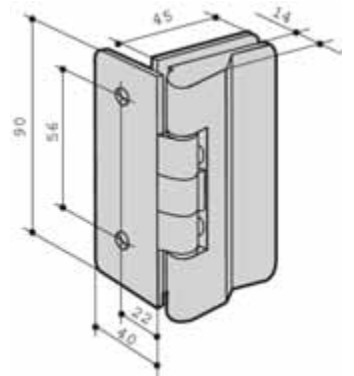

CS 716i/CA 726i



Wandmontage nach innen öffnend
Wall mount inward opening

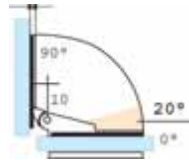

Glas/Wand 6 mm
Glass/Wall 6 mm

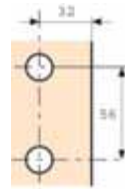

2 Bohrungen/Holes Ø18

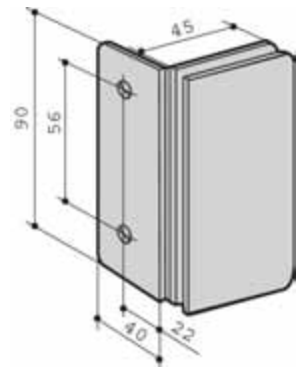

CS 715/CA 725



Glas/Glas 180° nach außen öffnend
Glass/Glass 180° outward opening

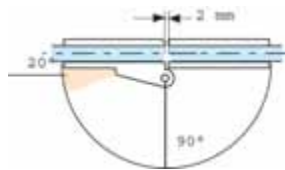

Glas/Glas 2 mm
Glass/Glass 2 mm

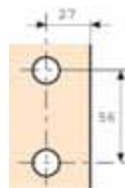

2 Bohrungen/Holes Ø18

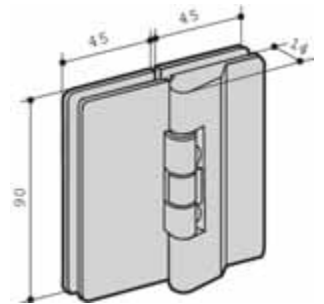

CS 715i/CA 725i



Glas/Glas 180° nach innen öffnend
Glass/Glass 180° inward opening

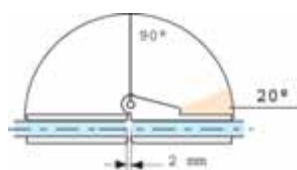

Glas/Glas 2 mm
Glass/Glass 2 mm

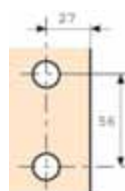

2 Bohrungen/Holes Ø18

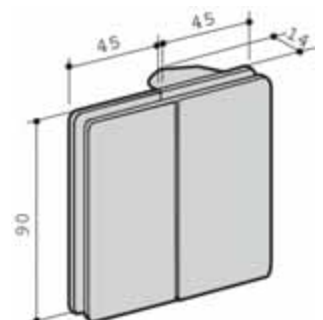

Das Multi-Positions Scharnier

The multiposition hinge

Toskana
Aquastar

CS 718/CA 728



Glas/Glas 135° nach außen öffnend
Glass/Glass 135° outward opening

Glas / Glass :
Stärke/Thickness : 6.8.10 mm
6 + 10 mm bitte angeben/tell us
Breite/Width : 800 mm max.
Gewicht/Weight : 35 kg max.

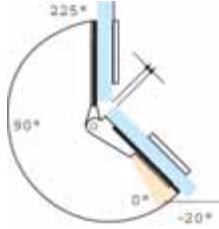

Glas/Glas 2 mm
Glass/Glass 2 mm

Scharnier/Hinge
massives Messing gefräst/Solid brass
Chromstärke/Chrome thickness : 40 µ

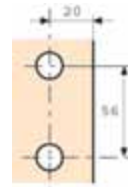

2 Bohrungen/Holes Ø18

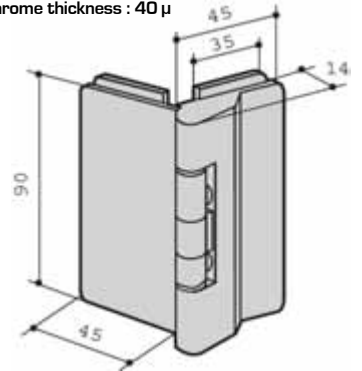

CS 718i/CA 728i



Glas/Glas 135° nach innen öffnend
Glass/Glass 135° inward opening

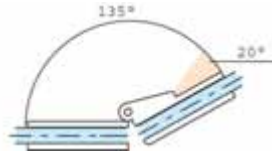

Glas/Glas 2 mm
Glass/Glass 2 mm

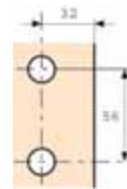

2 Bohrungen/Holes Ø18

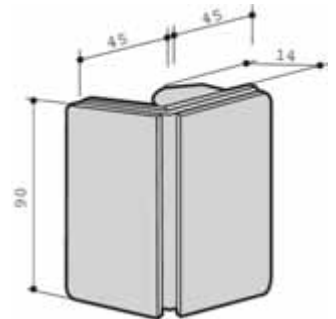

CS 717/CA 727



Glas/Glas 90° nach außen öffnend
Glass/Glass 90° outward opening

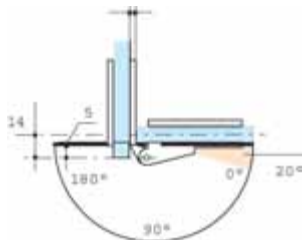

Glas/Glas 7 mm
Glass/Glass 7 mm

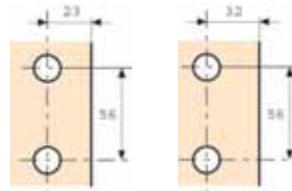

Fixteil
Fixed part

Türe
Mobile part

Je 2 Bohrungen/Holes Ø18
Fixteil/Fixed part 5mm =
vor Türe/before door

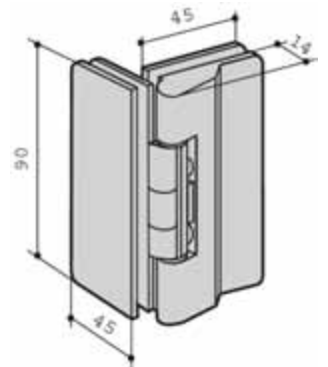

CS 717i/CA 727i



Glas/Glas 90° nach innen öffnend
Glass/Glass 90° inward opening

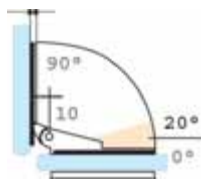

Glas/Glas 7 mm
Glass/Glass 7 mm

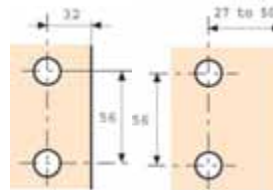

Türe
Mobile part

Fixteil
Fixed part

Je 2 Bohrungen/Holes Ø18
Fixteil/Fixed part 50mm =
Überlappung/Overlap 13mm

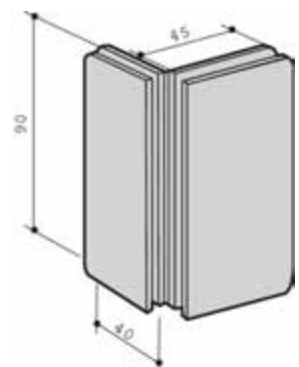

STARDUSCH

STARDOUCH

- Nach Installation der Scharniere entfernen Sie die 2 Fixiermadenschrauben.
- Setzen Sie einen Tropfen Silikon oder Kleber auf die Spitze der Fixiermadenschrauben und drehen Sie diese wieder ein.
- Stellen Sie die Türe auf die gewünschte Position und ziehen Sie die Schrauben gleichmäßig an.
- Kontrollieren Sie die Funktion der Türe.
- Nochmals bitte die 2 Schrauben anziehen.
- Die Selbstschließfunktion +/- 20 ° bleibt bestehen.

- After having installed the hinges on the wall or on the fixed pane, unscrew the 2 Allen screws
- Put a drop of silicone on the top of the screws. Insert the screws and adjust the required angle
- Make sure that you have thoroughly tightened the screws both sides (interior & exterior)
- Control the functioning of the door by moving it several times
- Again tighten the 2 Allen screws (interior & exterior)
- The self-closing area (20 degrees) remains effective

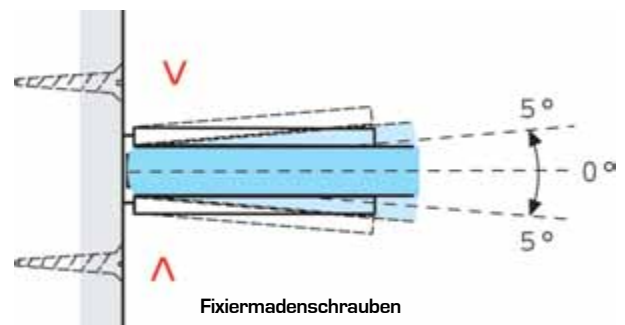

STARDUSCH

STARDOUCH

Das Pendeltürscharnier mit Feinjustierung

The adjustable swing door hinge

- - Pendeltürfunktion: nach Innen und Außen öffnend.
- Selbstschließende Funktion für die letzten 20 °.
- Eine große Menge an Grundscharnieren ermöglichen eine Vielfalt an verschiedenen Einbausituationen.
- Einfach zu Montieren, nach Montage kann die Türe +/- 5 ° eingestellt werden.
- Ästhetik und Funktionalität: die Wandplatte kann mit Langloch und Abdeckung geliefert werden (keine sichtbaren Wandschrauben).

- - Double action hinge: in AND out opening
- Self-closing function of the door on the last 20 degrees
- A large choice of angles offers many original possibilities of construction: folding doors, enclosure for bath tube, overlapping glass doors etc...
- Ease of mounting: adjustment of the closed position (+/- 5°) after the door has been installed
- Aesthetics and functionality : the wall plate can be delivered in a version with long holes (easy mounting) and cover (non visible wall screws).





CSF 60/CS 60



Wandbefestigung 4 Schrauben
Wall mount 4 screws

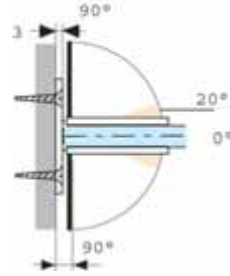

Glas/Wand 3 oder 5 mm
Glass/Wall 3 or 5 mm

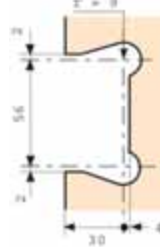

Für 3 mm Luft
For 3 mm gap

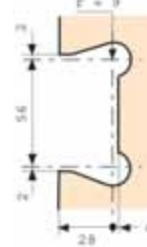

Für 5 mm Luft
For 5 mm gap

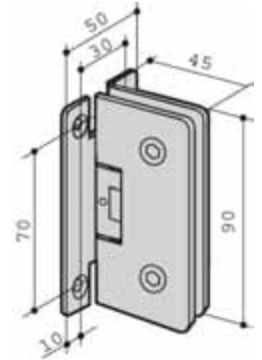

Scharnier/Hinge

massives Messing gefräst/Solid brass
Chromstärke/Chrome thickness : 40 µ

Glas / Glass :
Stärke/Thickness : 6.8.10 mm
6 + 10 mm bitte angeben/tell us
Breite/Width : 800 mm max.
Gewicht/Weight : 35 kg max.

CSF 620 /CS 620



Wandbefestigung 2 Schrauben
Wall mount 2 screws

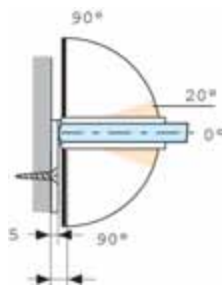

Glas/Wand 3 oder 5 mm
Glass/Wall 3 or 5 mm

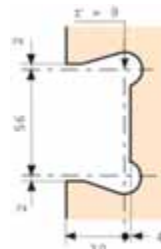

Für 3 mm Luft
For 3 mm gap

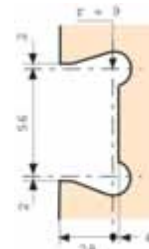

Für 5 mm Luft
For 5 mm gap

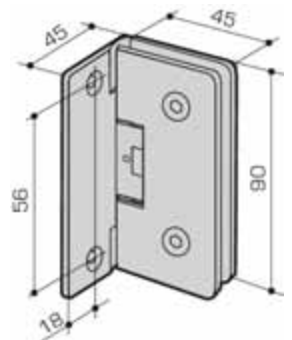

CSF 621/CS 621



Wandbefestigung einseitig mit Langlöchern und Abdeckung

Wall mounting with long holes and cover
Technische Spezifikationen wie CSF 620
Technical specifications as CS 620

CSF 64/CS 64



Wandbefestigung 135° / 4 Schrauben
Wall mount 135 degree° / 4 screws °

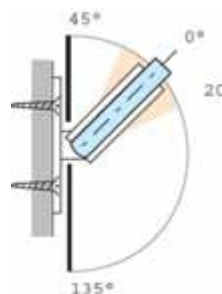

Glas/Wand 3 mm Luft
Glass/Wall 3 mm gap

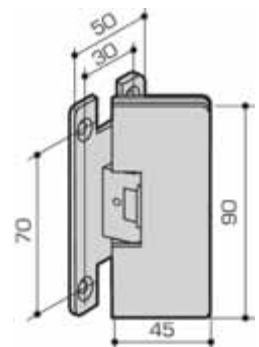
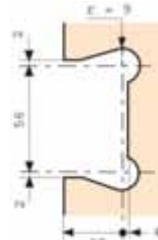

Das Pendeltürscharnier mit Feinjustierung

The adjustable swing door hinge



CSF 65/CS 65

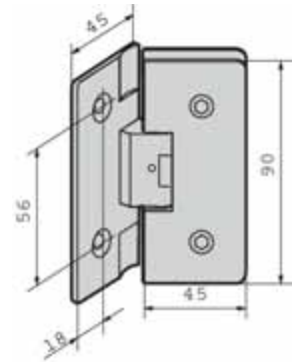
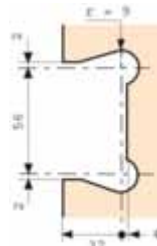
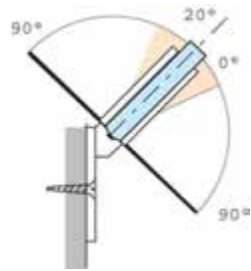

Wandbefestigung 135° / 2 Schrauben
Wall mount 135 degree° / 2 screws°

Glas/Wand 3 mm Luft
Glass/Wall 3 mm gap

CSF 66/CS 66

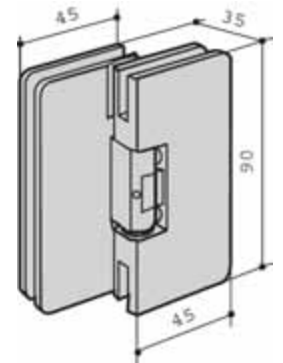
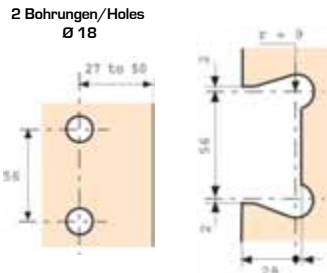
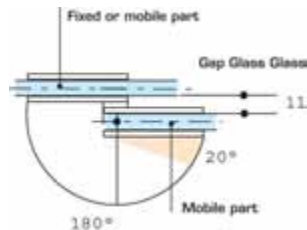

Glas / Glass :

Stärke/Thickness : 6.8.10 mm
6 + 10 mm bitte angeben/tell us
Breite/Width : 800 mm max.
Gewicht/Weight : 35 kg max.

Scharnier/Hinge
massives Messing gefräst/Solid brass
Chromstärke/Chrome thickness : 40 µ

Glas/Glas Scharnier überlappend
Glass/Glass hinge overlapping

Überlappung des Glasses
Overlapping of Glass
27mm = 13 mm Überlappt/overlapp

Fixteil
Fixed part

Türe
Mobile part

CSF 61/CS 61

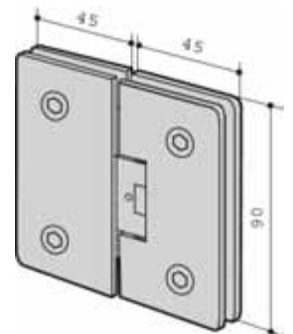
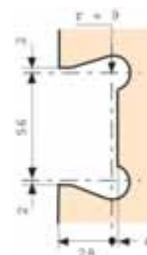
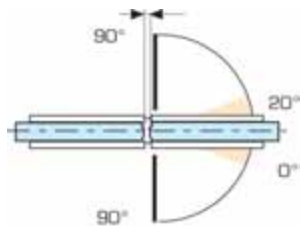

Glas/Glas fluchtend
Glass/Glass in extension

Glas/Glas 2 mm Luft
Glass/Glass 2 mm gap

CSF 610/CS 610

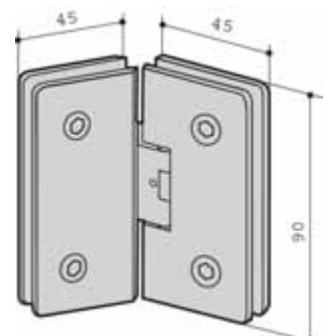
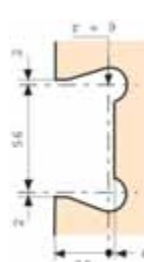
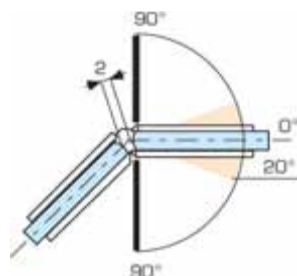

Glas/Glas 135°
Glass/Glass 135°degree

Glas/Glas 2 mm Luft
Glass/Glass 2 mm gap



CSF 62/CS 62



Glas/Glas 90°
Glass/Glass 90° degree

Glas / Glass :
Stärke/Thickness : 6.8.10 mm
6 + 10 mm bitte angeben/tell us
Breite/Width : 800 mm max.
Gewicht/Weight : 35 kg max.

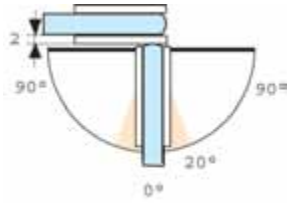

Glas/Glas 4 mm Luft
Glass/Glass 4 mm gap

2 Bohrungen/Holes
Ø 18

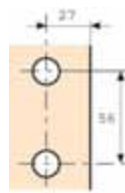

Fixteil
Fixed part part

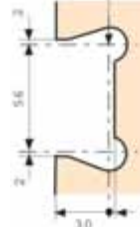

Türe
Mobile part

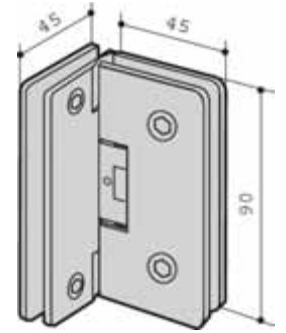

CS 507



Wandwinkel 90°
Wall angle 90° degree

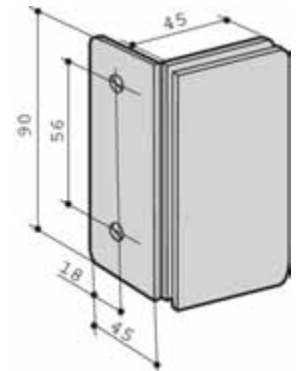
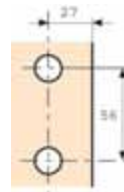
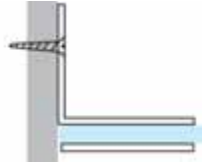

CS 517

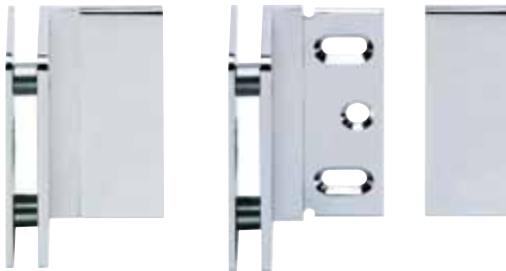

Wandwinkel einseitig mit Langlöchern und Abdeckung
Wall angle with long holes and cover
Technische Spezifikationen wie CS 507
Technical specifications as CS 507

2 Bohrungen/Holes
Ø 18
0 mm Luft/gap

CS 506



Glas/Glas Winkel 90°
Glass/Glass angle 90° degree

2 Bohrungen/Holes
Ø 18

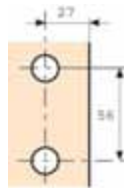

2 Bohrungen/Holes
Ø 18

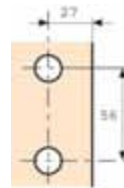

+ Glasstärke
+ Glass thickness
z.B./for example:
27 mm + 8 mm
Glas/Glass =
35 mm

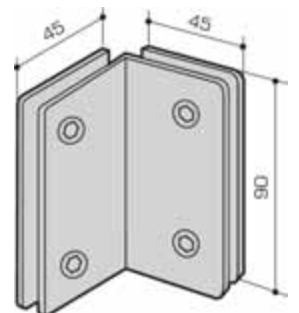

Das Pendeltürscharnier mit Feinjustierung

The adjustable swing door hinge

CS 508

2 mm Luft/Innen- / 8 mm Luft/Aussenseite
2 mm gap inside / 8 mm gap outside glass

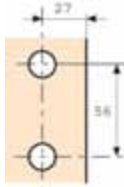
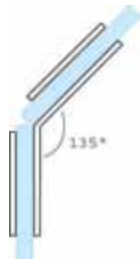

2 Bohrungen/Holes
Ø18

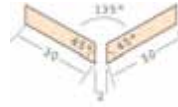

2 Bohrungen/Holes
Ø18

2 mm Luft auf Innen- und Aussenseite
2 mm gap In- and Outside

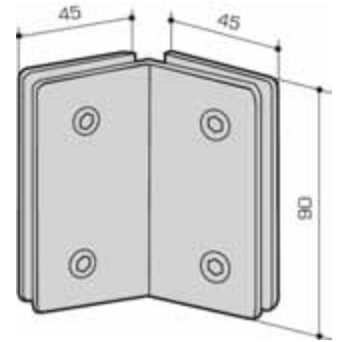

Glas/Glas Winkel 135°
Glass/Glass angle 135 degree°

CS 509

9 mm Luft/Innen- / 0 mm Luft/Aussenseite
9 mm gap inside / 0 mm gap outside glass

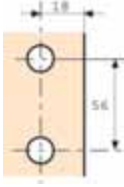
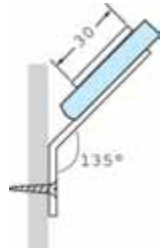

2 Bohrungen/Holes
Ø18

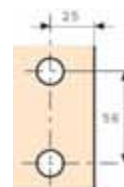

2 Bohrungen/Holes
Ø18

2 mm Luft auf Innen- und Aussenseite
2 mm gap In- and Outside

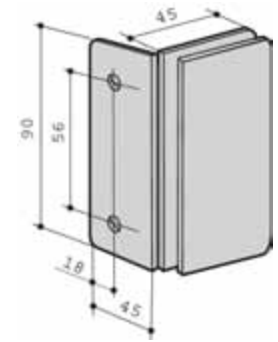

Wandwinkel 135°
Wall angle 135° degree

CS 505 / CS 062

Glas / Glass :
Stärke/Thickness : 6.8.10 mm
6 + 10 mm bitte angebe/tell us
Breite/Width : 800 mm max.
Gewicht/Weight : 35 kg max.

Scharnier/Hinge
massives Messing gefräst/Solid brass
Chromstärke/ Chrome thickness : 40 µ

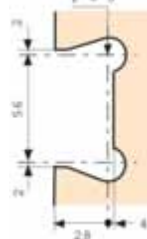

Für CS 505
For CS 505
0 mm Luft/gap

CS 505 = Wandwinkel 90°
CS 062 = Gegenplatte zur Glas/Glas Montage für
CSF 620/CS 507/CS 511 und CSF 65
CS 505 = Wall angle 90 degree
CS 062 = counterplate for Glass/Glass on CS 620/CS 507/CS 511 and CS 65

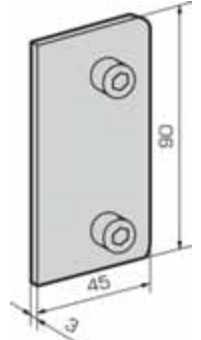
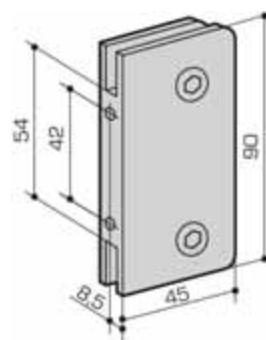

CS 510

CS 511

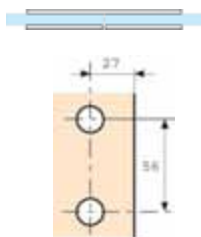

2 x 2 Bohrungen/
Holes Ø 18

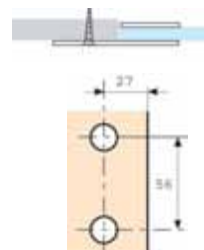
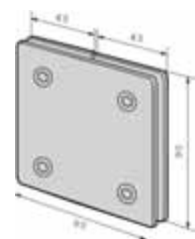

2 Bohrungen/Holes
Ø 18

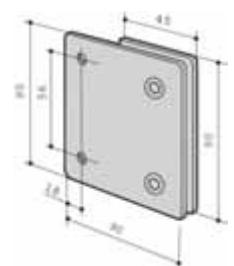

Glas/Glas Verbinder 180°
Glass/Glass connection 180 degree

Wand/Glas Verbinder 180°
Wall/Glass connection 180° degree



GENERAL INFORMATION

INFORMATIONS GENERALES

Einsatzmöglichkeiten der Scharniere
Models and installation possibilities

Farben und Formen - Technische Daten
Finish and design - Technical Data

Pflege & Wartung der Scharniere
Care & Maintenance of hinges

Allgemeine Geschäftsbedingungen
General Sales Conditions



Toscana

Visiostar

Stardusch

Oceane

Starlett

Europa

Oceane flex

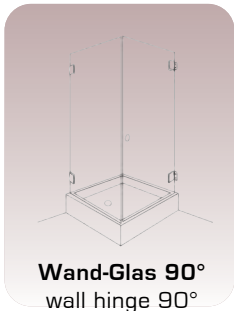

CS716
CS716-I

CSF60 - CSF620 - CSF621
CSOM - CS2M

CS 1000
CS 2000

SL40

CP 78

CS 1600
CS 2600

Feste Wandverbindungen:
CS505 - CS507 - CS7M
CS517

Feste Wand-
verbindung:
CS1400

Feste Wand-
verbindung:
SL47



CSF64 - CSF65

Feste Wandverbindung:
CS509

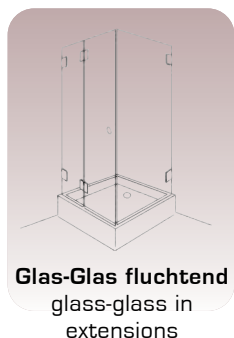

CS715
CS715-I

CS1M - CSF61 - CSF66

CS 1100
CS 2100

SL 41

CP 781

Feste Glasverbindung: CS510
Feste Wandverbindung: CS511

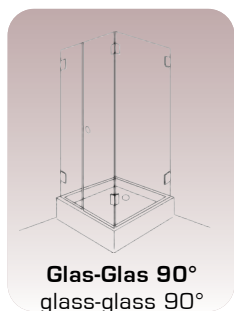

CS717
CS717I

CSF62

CS 1200
CS 2200

SL42

Feste Glasverbindung:
CS506

Feste Glas-
verbindung:
SL46

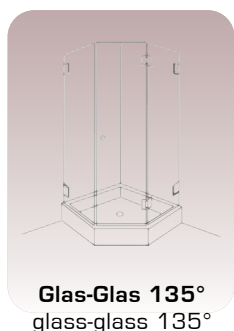

CS718
CS718I

CSF610

CS 1300
CS 2300

SL 43

Feste Glasverbindung:
CS508



	Visiostar	Toscana	Stardusch	Oceane	Starlett	Europa
Design						
Glasstärke Auf Anfrage	8 mm 10 mm	6-8 mm 10 mm	6-8 mm 10 mm	8-10 mm	6-8 mm	8-10 mm
Max. Türbreite Glasgewicht	800 mm 35 kg	800 mm 35 kg	800 mm 35 kg	900 mm 45 kg	650 mm 20 kg	900 mm 45 kg
Material	Messing Brass	Messing Brass	Messing Brass	Messing Brass	Messing Brass	Aluminium Aluminium
Automatische Rückholzone	± 20°	± 20°	± 20°	± 20°	± 20°	± 85°

Ausführungen und Farbe

Toscana	messing poliert = MP/LP	mattver- -chromt = MV/LM	vergoldet * = VG/DI	 Sonderfarben nach RAL
Stardusch				
Oceane	glanzver- -chromt = GV/LC	weiß = W/LB RAL 9010	Edelstahl Finish = EF/NB	
Oceane flex				
Starlett				
Visiostar				

* Industrievergoldet 0,5 - 0,7 micron

Europa	silber elox. = EV 1/AS 1	braun elox. = MC/BS 6	weiß = W/LB RAL 9010
	goldfarbig elox. = EV 5/OR 3	schwarz elox. = SW/NS	

FRAGEN Sie uns... Contact us...

... nach dem Katalog
für elektrische Schlösser
... to get our catalogue of
electric locking solutions



Elektrische Schlösser für Glastüren
Electric Locks for glass doors

Elektrische Schlösser für Sicherheitstüren
High Security Electric Locks



Elektrische Schlösser
für Notausgänge
Electric Locks
for Emergency Exits



HAUPTKATALOG

CATALOGUE

CRÉATIONS
D. GUIDOTTI

glasmanufaktur.ch

GLASMANUFAKTUR BUTTIKON AG



Träume aus Glas

Glaszuschnitt
Glasbearbeitung
Glasreparaturen
Spiegel
Glasmöbel
Glasschiebetüren
Glastüren
Glastritte
Glasgeländer
Küchenrückwände
Terrassen - und
Balkonverglasungen
Dachverglasungen
Glasduschen
Isolierverglasungen
Sicherheitsglas
korrosionsbeständiges Duschenglas
usw.